

Breakdown Voltage: 6.8 to 600 V
Peak Pulse Power: 400 W

Surface Mount Transient Voltage Suppressors

Features

- Glass passivated chip
- 400 W peak pulse power capability with a 10/1000 μ s waveform, repetitive rate (duty cycle):0.01 %
- Low leakage
- Uni and Bidirectional unit
- Excellent clamping capability
- Very fast response time
- RoHS compliant

Mechanical Data

- Case: Molded plastic
- Epoxy: UL 94V-0 rate flame retardant
- Lead: Solderable per MIL-STD-750, method 2026
- Polarity: Color band denotes cathode end except Bipolar
- Mounting position: Any

SMA/ DO-214AC

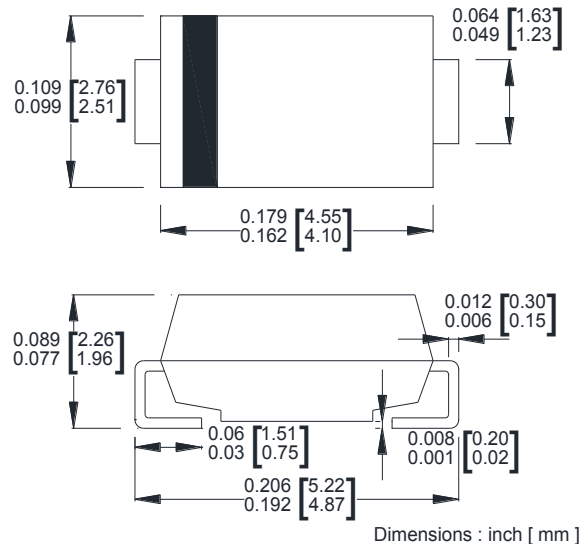

Maximum Ratings($T_A=25^\circ\text{C}$ unless otherwise noted)

Parameter	Symbol	Value	Unit
Peak power dissipation with a 10/1000 μ s waveform ⁽¹⁾	P_{PP}	400	W
Peak pulse current with a 10/1000 μ s waveform ⁽¹⁾	I_{PP}	See Next Table	A
Power dissipation on infinite heatsink at $T_L = 75^\circ\text{C}$	P_D	1.0	W
Peak forward surge current, 8.3 ms single half sine-wave unidirectional only ⁽²⁾	I_{FSM}	40	A
Maximum instantaneous forward voltage at 25 A for unidirectional only ⁽³⁾	V_F	3.5/5.0	V
Operating junction and storage temperature range	T_J, T_{STG}	- 55 to +150	$^\circ\text{C}$

Note:

(1)Non-repetitive current pulse per Fig.5 and derated above $T_A = 25^\circ\text{C}$ per Fig.1

(2)Measured on 8.3 ms single half sine-wave or equivalent square wave, duty cycle = 4 pulses per minute maximum

(3) $V_F < 3.5\text{V}$ for devices of $V_{BR} < 200\text{V}$ and $V_F < 5.0\text{V}$ for devices of $V_{BR} > 201\text{V}$

Ratings and Characteristics Curves ($T_A=25^\circ\text{C}$ unless otherwise noted)

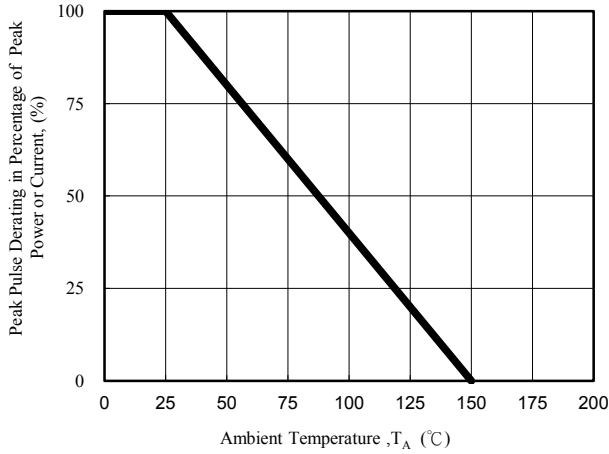

Fig. 1 - Pulse Derating Curve

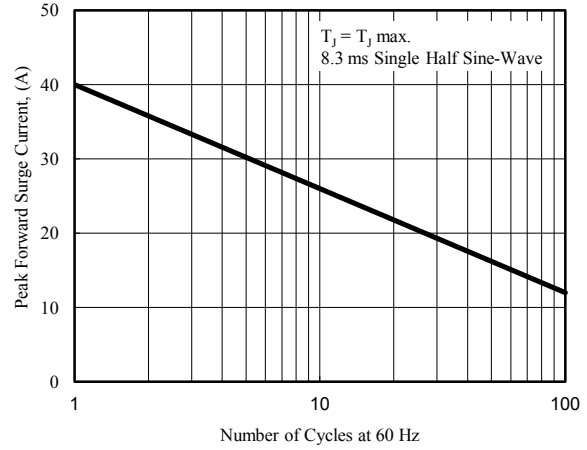

Fig. 2 - Maximum Non-Repetitive Surge Current

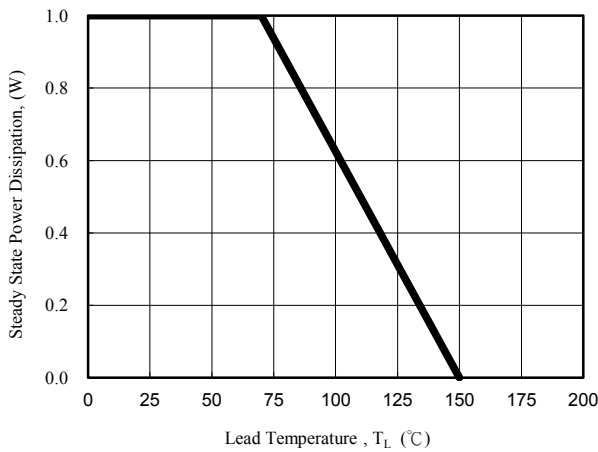

Fig. 3 - Steady State Power Derating Curve

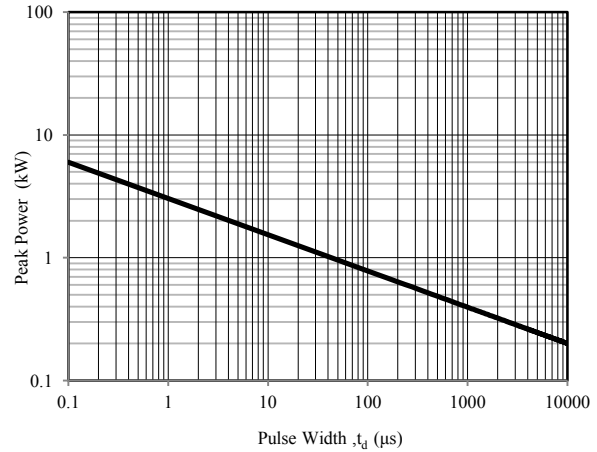

Fig. 4 - Peak Pulse Power Rating Curve

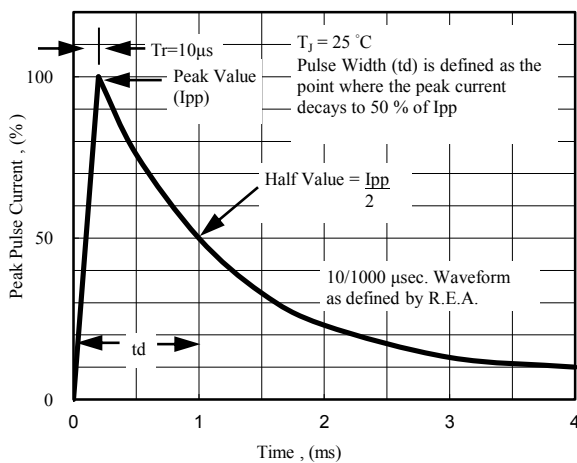

Fig. 5 - Pulse Waveform

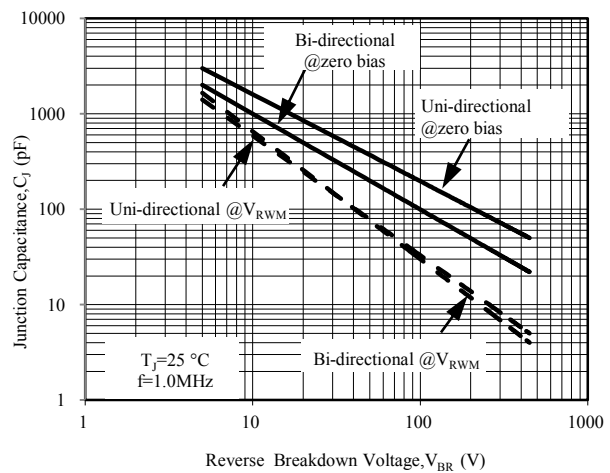

Fig. 6 - Typical Junction Capacitance

Electrical Characteristics($T_A=25^{\circ}\text{C}$ unless otherwise noted)

Part Number (Uni)	Part Number (Bi)	Device Marking Code		Breakdown Voltage V_{BR} @ I_T			Maximum Reverse Leakage I_R @ V_{RWM} (μA)	Working Peak Reverse Voltage V_{RWM} (V)	Maximum Reverse Surge Current I_{PP} (A)	Maximum Clamping Voltage V_C @ I_{PP} (V)
		Uni	Bi	Min (V)	Max (V)	I_T (mA)				
P4SMA6.8A	P4SMA6.8CA	6V8A	6V8C	6.46	7.14	10	1000	5.8	38.10	10.5
P4SMA7.5A	P4SMA7.5CA	7V5A	7V5C	7.13	7.88	10	500	6.4	35.40	11.3
P4SMA8.2A	P4SMA8.2CA	8V2A	8V2C	7.79	8.61	10	200	7.0	33.06	12.1
P4SMA9.1A	P4SMA9.1CA	9V1A	9V1C	8.65	9.56	1	50	7.8	29.85	13.4
P4SMA10A	P4SMA10CA	10A	10C	9.50	10.50	1	10	8.6	27.59	14.5
P4SMA11A	P4SMA11CA	11A	11C	10.45	11.55	1	5	9.4	25.64	15.6
P4SMA12A	P4SMA12CA	12A	12C	11.40	12.60	1	5	10.2	23.95	16.7
P4SMA13A	P4SMA13CA	13A	13C	12.35	13.65	1	1	11.1	21.98	18.2
P4SMA15A	P4SMA15CA	15A	15C	14.25	15.75	1	1	12.8	18.87	21.2
P4SMA16A	P4SMA16CA	16A	16C	15.20	16.80	1	1	13.6	17.78	22.5
P4SMA18A	P4SMA18CA	18A	18C	17.10	18.90	1	1	15.3	15.87	25.2
P4SMA20A	P4SMA20CA	20A	20C	19.00	21.00	1	1	17.1	14.44	27.7
P4SMA22A	P4SMA22CA	22A	22C	20.90	23.10	1	1	18.8	13.07	30.6
P4SMA24A	P4SMA24CA	24A	24C	22.80	25.20	1	1	20.5	12.05	33.2
P4SMA27A	P4SMA27CA	27A	27C	25.65	28.35	1	1	23.1	10.67	37.5
P4SMA30A	P4SMA30CA	30A	30C	28.50	31.50	1	1	25.6	9.66	41.4
P4SMA33A	P4SMA33CA	33A	33C	31.35	34.65	1	1	28.2	8.75	45.7
P4SMA36A	P4SMA36CA	36A	36C	34.20	37.80	1	1	30.8	8.02	49.9
P4SMA39A	P4SMA39CA	39A	39C	37.05	40.95	1	1	33.3	7.42	53.9
P4SMA43A	P4SMA43CA	43A	43C	40.85	45.15	1	1	36.8	6.75	59.3
P4SMA47A	P4SMA47CA	47A	47C	44.65	49.35	1	1	40.2	6.17	64.8
P4SMA51A	P4SMA51CA	51A	51C	48.45	53.55	1	1	43.6	5.71	70.1
P4SMA56A	P4SMA56CA	56A	56C	53.20	58.80	1	1	47.8	5.19	77.0
P4SMA62A	P4SMA62CA	62A	62C	58.90	65.10	1	1	53.0	4.71	85.0
P4SMA68A	P4SMA68CA	68A	68C	64.60	71.40	1	1	58.1	4.35	92.0
P4SMA75A	P4SMA75CA	75A	75C	71.25	78.75	1	1	64.1	3.88	103.0
P4SMA82A	P4SMA82CA	82A	82C	77.90	86.10	1	1	70.1	3.54	113.0
P4SMA91A	P4SMA91CA	91A	91C	86.45	95.55	1	1	77.8	3.20	125.0
P4SMA100A	P4SMA100CA	100A	100C	95.00	105.00	1	1	85.5	2.92	137.0
P4SMA110A	P4SMA110CA	110A	110C	104.50	115.50	1	1	94.0	2.63	152.0
P4SMA120A	P4SMA120CA	120A	120C	114.00	126.00	1	1	102.0	2.42	165.0
P4SMA130A	P4SMA130CA	130A	130C	123.50	136.50	1	1	111.0	2.23	179.0
P4SMA150A	P4SMA150CA	150A	150C	142.50	157.50	1	1	128.0	1.93	207.0
P4SMA160A	P4SMA160CA	160A	160C	152.00	168.00	1	1	136.0	1.83	219.0
P4SMA170A	P4SMA170CA	170A	170C	161.50	178.50	1	1	145.0	1.71	234.0
P4SMA180A	P4SMA180CA	180A	180C	171.00	189.00	1	1	154.0	1.63	246.0
P4SMA200A	P4SMA200CA	200A	200C	190.00	210.00	1	1	171.0	1.46	274.0
P4SMA220A	P4SMA220CA	220A	220C	209.00	231.00	1	1	185.0	1.22	328.0
P4SMA250A	P4SMA250CA	250A	250C	237.50	262.50	1	1	214.0	1.16	344.0
P4SMA300A	P4SMA300CA	300A	300C	285.00	315.00	1	1	256.0	0.97	414.0
P4SMA350A	P4SMA350CA	350A	350C	332.50	367.50	1	1	299.3	0.83	482.0
P4SMA380A	P4SMA380CA	380A	380C	361.00	399.00	1	1	324.9	0.76	524.4
P4SMA400A	P4SMA400CA	400A	400C	380.00	420.00	1	1	342.0	0.72	552.0
P4SMA440A	P4SMA440CA	440A	440C	418.00	462.00	1	1	376.2	0.66	607.2
P4SMA500A	P4SMA500CA	500A	500C	475.00	525.00	1	1	427.5	0.58	690.0
P4SMA520A	P4SMA520CA	520A	520C	494.00	546.00	1	1	444.6	0.56	717.6
P4SMA550A	P4SMA550CA	550A	550C	522.50	577.50	1	1	470.3	0.53	759.0
P4SMA600A	P4SMA600CA	600A	600C	570.00	630.00	1	1	513.0	0.48	828.0

Note:

1. The available parts are "A" type only, the parts without A (V_{BR} is $\pm 10\%$) is not available
2. Add suffix 'C' or 'CA' after part number to specify Bi-directional devices
3. For Bi-Directional devices having V_R of 10 volts and under, the I_R limit is double